

Draco

User's Manual







Foreword

General

This manual introduces the functions and operations of Draco multispectral binocular camera (hereinafter referred to as "the Camera"). Read carefully before using the device, and keep the manual safe for future reference.

Safety Instructions

The following signal words might appear in the manual.

Signal Words	Meaning
 DANGER	Indicates a high potential hazard which, if not avoided, will result in death or serious injury.
 WARNING	Indicates a medium or low potential hazard which, if not avoided, could result in slight or moderate injury.
 CAUTION	Indicates a potential risk which, if not avoided, could result in property damage, data loss, reductions in performance, or unpredictable results.
 LASER RADIATION	Indicates a laser radiation hazard. Take care to avoid exposure to a laser beam.
 NOTE	Provides additional information as a supplement to the text.

Revision History

Version	Revision Content	Release Time
V1.0.0	First release.	October 2025

Privacy Protection Notice

As the device user or data controller, you might collect the personal data of others such as their face, fingerprints, and license plate number. You need to be in compliance with your local privacy protection laws and regulations to protect the legitimate rights and interests of other people by implementing measures which include but are not limited: Providing clear and visible identification to inform people of the existence of the surveillance area and provide required contact information.

About the Manual

- The manual is for reference only. Slight differences might be found between the manual and the product.
- We are not liable for losses incurred due to operating the product in ways that are not in compliance with the manual.
- The manual will be updated according to the latest laws and regulations of related jurisdictions. For detailed information, see the paper user's manual, use our CD-ROM, scan the QR code or visit our official website. The manual is for reference only. Slight differences might be found between the electronic version and the paper version.
- All designs and software are subject to change without prior written notice. Product updates

might result in some differences appearing between the actual product and the manual. Please contact customer service for the latest program and supplementary documentation.

- There might be errors in the print or deviations in the description of the functions, operations and technical data. If there is any doubt or dispute, we reserve the right of final explanation.
- Upgrade the reader software or try other mainstream reader software if the manual (in PDF format) cannot be opened.
- All trademarks, registered trademarks and company names in the manual are properties of their respective owners.
- Please visit our website, contact the supplier or customer service if any problems occur while using the device.
- If there is any uncertainty or controversy, we reserve the right of final explanation.

Important Safeguards and Warnings

This section introduces content covering the proper handling of the device, hazard prevention, and prevention of property damage. Read carefully before using the device, and comply with the guidelines when using it.

Transportation Requirements



- Transport the Camera within the allowed humidity and temperature conditions.
- Do not fall, squeeze, violently vibrate or immerse the device in liquid when transporting. Gently pick and place the Camera when moving, prevent the internal equipment becoming damaged or cable connection becoming loose.
- Do not transport the Camera without package. Use the factory default package or material of equal quality to pack the Camera when transporting it, otherwise the Camera can become easily damaged.

Storage Requirements



- Store the Camera within the allowed humidity and temperature conditions.
- Do not place the device in a humid, dusty or extremely hot or cold site that has strong electromagnetic radiation or unstable illumination.
- Do not squeeze, violently vibrate or immerse the device in liquid.
- Do not mechanically vibrate or crash when storing.
- Store the Camera in a ventilated place that has no strong electromagnetic radiation.
- For long-term storage of the battery, make sure that it is fully charged every half year to ensure the battery quality. Otherwise, damage may occur.

Operation Requirements



- Prevent liquid from flowing into the Camera to avoid damage to the internal components.
- Do not stuff foreign materials into the Camera to prevent a short circuit which could result in the Camera being damaged or people becoming injured.
- Do not expose the device to high electromagnetic radiation or dusty environments.
- Do not aim the lens at the sun or any other bright light.
- Improper use or replacement of the battery may result in explosion hazard.
- Do not charge other battery types with the supplied charger. Confirm there is no flammable material within 2 m of the charger during charging.
- Make sure that the plug is properly connected to the power socket.
- Do not connect multiple devices to one power adapter, to avoid over-heating or fire hazards caused by overload.
- If smoke, odor, or noise arises from the device, immediately turn off the power, unplug the power cable, and contact the service center.



- Do not dismantle the Camera. The internal components can only be repaired by a qualified professional. Dismantling it without professional assistance might cause water seeping in or might result in the Camera producing poor quality images.
- Operating temperature: $-30\text{ }^{\circ}\text{C}$ to $+55\text{ }^{\circ}\text{C}$ ($-22\text{ }^{\circ}\text{F}$ to $+121\text{ }^{\circ}\text{F}$), and the operating humidity shall be 95% or less.

Maintenance and Repair Requirements



DANGER

- Prevent liquid from flowing into the Camera to avoid damage to the internal components. In case the liquid enters the Camera, immediately stop using the Camera, cut off the power, and disconnect all the cables, and then contact your local customer service center.
- Use the accessories regulated by the manufacturer. The Camera should be maintained by qualified professionals.
- Make sure to cut off the power before cleaning the Camera, to prevent electric shock.



WARNING

If the Camera malfunctions, contact your local customer service center. Do not dismantle the Camera.



- Clean the Camera body with a piece of soft dry cloth. For any dirt that is hard to remove, pick up a piece of clean and soft cloth, dip it into a little neutral detergent and gently wipe the dust away. After that, wipe away all the remaining liquid on the Camera with another dry cloth. Never use volatile solvents such as alcohol, benzene and thinner, or cleaners that are strong and abrasive. Otherwise, the Camera's surface coating will be damaged and its working performance will be encumbered.
- Save the factory package of the Camera. When the Camera malfunctions, pack the Camera with the factory package and send to the dealer.

Laser Requirements



LASER RADIATION

Laser can cause damages to eyes. Do not look directly at the laser beam or observe the beam with optical devices when the laser is on.

Table of Contents

Foreword	I
Important Safeguards and Warnings.....	III
1 Product Introduction	1
2 Structure	2
2.1 Packing List.....	2
2.2 Device Description.....	3
3 Basic Operation	6
3.1 Buttons.....	6
3.2 Initializing Camera.....	6
3.3 Starting and Shutdown	7
3.3.1 Manual Starting and Shutdown	7
3.3.2 Auto Shutdown.....	7
3.4 Image Adjustment.....	7
3.4.1 Adjusting IR Light.....	7
3.4.2 Adjusting Focus	8
3.4.3 Adjusting Diopter.....	8
3.4.4 Adjusting Pupil Distance.....	8
3.4.5 Setting Scene Mode.....	9
3.4.6 Setting Defog.....	9
3.4.7 Setting EIS	9
3.4.8 Setting IR Light.....	9
3.4.9 Setting Image Mode.....	10
3.4.10 Setting Digital Zoom	10
3.4.11 Setting Color Palettes	10
3.4.12 Setting Status Bar	14
3.4.13 Setting PIP	14
3.5 Configuring the Camera.....	15
3.5.1 Setting Wi-Fi Connection	15
3.5.2 Setting Hot Point.....	16
3.5.3 Setting Compass	16
3.5.4 Setting GPS	16
3.5.5 Setting LRF	16
3.5.6 Setting Thermal Calibration.....	17
3.5.7 Setting DPC.....	17
3.5.8 Function Settings.....	17

3.5.9 System Settings	18
3.6 Video and Snapshot	19
3.6.1 Recording Videos	19
3.6.2 Capturing Images	19
3.6.3 Viewing Local Album	20
3.6.4 Exporting File	20
3.7 Power Supply	20
3.7.1 Installing the Battery	20
3.7.2 Charging	21
4 System Update	22
4.1 Upgrading Manually	22
4.2 Upgrading through App	22
Appendix 1 Compliance Notice	23







1 Product Introduction

The Draco series is a binocular camera compatible with both visible lens and thermal lens. The camera quickly scans and searches for targets in open fields through the thermal lens, and then identifies targets through the visible lens. Designed to enhance situational awareness at any time of day, the camera can detect humans, animals, and objects during both day and night, providing reliable images for law enforcement officers, hunters, and outdoor enthusiasts. The camera is also equipped with a built-in laser range finder for precise distance measurement to targets, and an integrated IR Emitter for a clear view in total darkness.

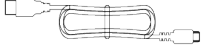
2 Structure

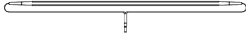
2.1 Packing List

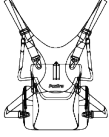
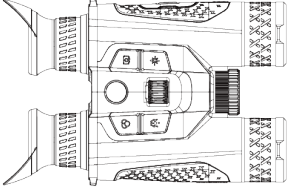
Figure 2-1 Packing list

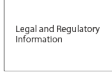
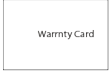
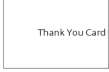
		
Type-C Cable × 1	Battery 18650 × 4	Battery Charger × 1
		
Neck Strap × 1	Lens Cloth × 1	Camera Bag × 1
		
Multispectral Binocular Camera × 1	Quick Start Guide × 1	Legal and Regulatory Information × 1
		
		Warranty Card × 1
		
	Thank You Card × 1	

2.2 Device Description

Figure 2-2 Buttons

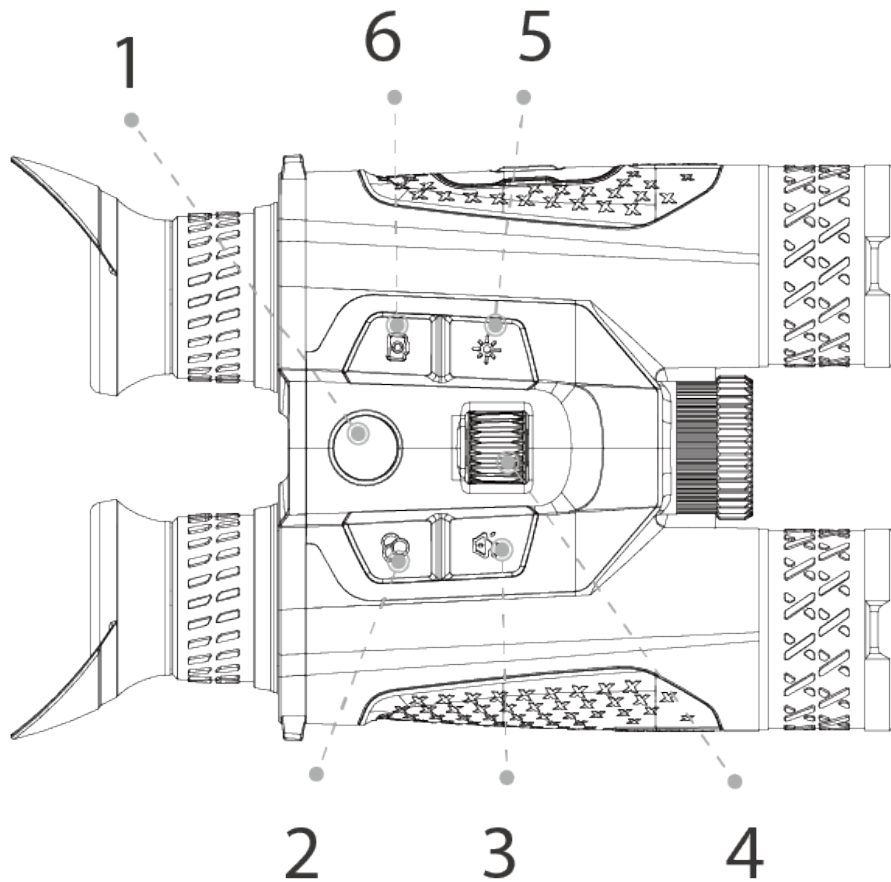

Table 2-1 Button description

No.	Name	Description
1	Power button	<ul style="list-style-type: none"> Press and hold the button to start or shut down the Camera. Press the button to enable or disable the standby mode.
2	Color Palettes button	<ul style="list-style-type: none"> Press the button to select the color palettes. Press and hold the button to manually adjust the shutter for the thermal image or switch day/twilight/night mode for the visible image.
3	Illuminator button	<ul style="list-style-type: none"> Press the button to turn on the IR light. Press and hold the button to switch the IR light mode.
4	Menu/Digital zoom wheel	<ul style="list-style-type: none"> Press and hold the wheel to go to the main menu. On the viewing page, rotate the wheel to do digital zoom.
5	Ranging button	<ul style="list-style-type: none"> Press the button to do ranging. Press and hold the button to enable the PIP mode. Double-press the button to disable the PIP mode. <p>⚠ LASER RADIATION Laser can cause damages to eyes. Do not look directly at the laser beam or observe the beam with optical devices when the laser is on.</p>

No.	Name	Description
6	Capture button	<ul style="list-style-type: none"> ● Press and hold the button to record videos. ● Press to capture images.

Figure 2-3 Components

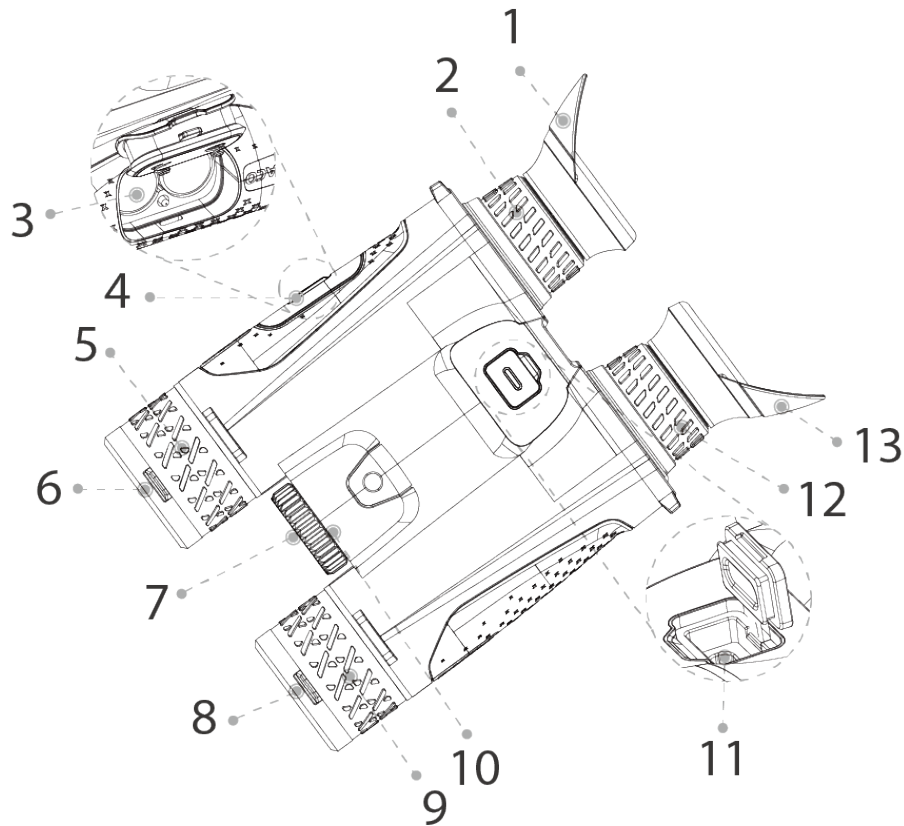



Table 2-2 Component description

No.	Name	Description
1 & 13	Eyeshade	Protects the eyes from glare.
2 & 12	Diopter adjustment ring	Adjust the ring according to your eyesight.
3	Battery compartment	The place for holding the battery.
4	Battery compartment switch	Locks/Unlocks the cover of the battery compartment.
5	Focus ring 1	Manually rotate the ring to adjust the focus for a clear visible image.
6	Visible lens	For visible imaging.
7	IR module	<p>Helps to view the target more clearly in the dark environment. The IR illuminator can be replaceable.</p> <p>⚠ LASER RADIATION Laser can cause damages to eyes. Do not look directly at the laser beam or observe the beam with optical devices when the laser is on.</p>
8	Thermal lens	For thermal imaging.

No.	Name	Description
9	Focus ring 2	Manually rotate the ring to adjust the focus for a clear thermal image.
10	Laser range finder	<p>Measures the distance between the Camera and the target with laser.</p> <p> LASER RADIATION</p> <p>Laser can cause damages to eyes. Do not look directly at the laser beam or observe the beam with optical devices when the laser is on.</p>
11	Type-C port	<ul style="list-style-type: none"> • Connects to a data cable for charging. • Connects to the Camera to a computer for exporting files.

3 Basic Operation

3.1 Buttons

When the Camera is on, press and hold the wheel to go to the main menu. Functions of all buttons are as follows.

- Rotate the wheel to move upward or downward the cursor.
- Press the wheel to set the parameters and confirm.
- Press and hold the wheel or press the power button to exit.

3.2 Initializing Camera

Set the language, Wi-Fi password and device time when you start the Camera for the first time or after you have restored your camera to default settings.

Step 1 Press and hold the power button to start the Camera, and the language setting screen is displayed.

Step 2 Set the language.

- 1) Rotate the wheel to select the language.
- 2) Press the wheel.

The password setting screen is displayed.

Step 3 Set the Wi-Fi password.

- 1) Rotate the wheel to select the digital to be set.
 - 2) Press the wheel.
 - 3) Rotate the wheel to set the value, and then press the wheel to save the configuration.
- Repeat 1)–3) to set the numbers of the Wi-Fi password one by one.

Figure 3-1 Set password

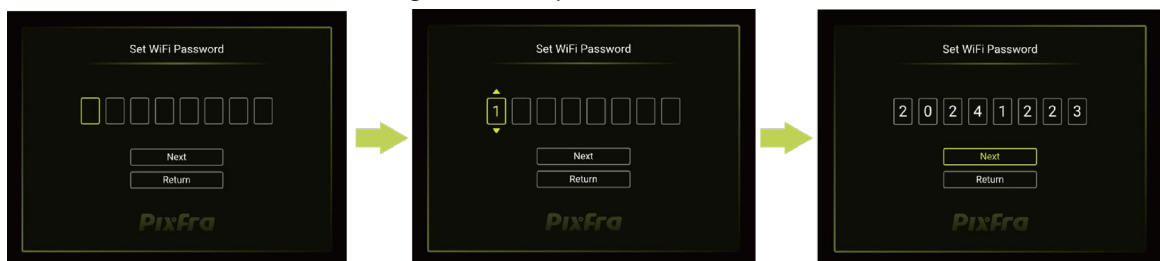

Step 4 Rotate the wheel to select **Next**, and then press the wheel. The time setting screen is displayed.

Step 5 Set the device time.

- 1) Rotate the wheel to select the digital to be set.
- 2) Press the wheel and then rotate it to set the value.

Repeat 1)–2) to set the numbers of time one by one.

Figure 3-2 Set device time

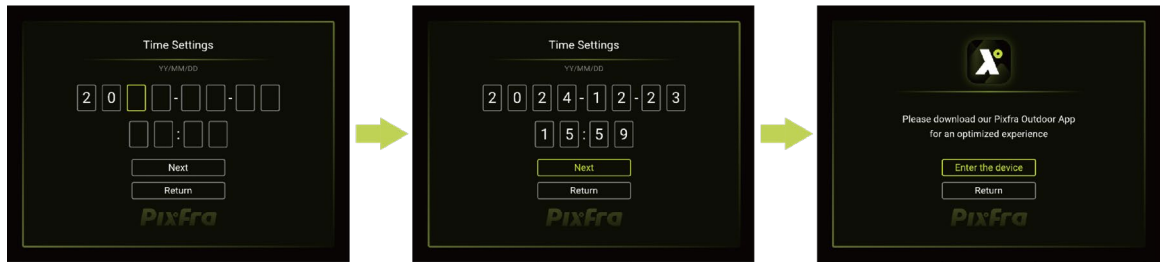

Step 6 Rotate the wheel to select **Next**, and then press the wheel.

Step 7 Rotate the wheel to select **Enter the Device**.
The viewing screen is displayed.

3.3 Starting and Shutdown

3.3.1 Manual Starting and Shutdown

Press and hold the power button to start or shut down the Camera; press the power button to go to the standby mode.



After starting the Camera, remove the protective cover of the lens.

- When the Camera is off, press and hold the power button to start it.
- When the Camera is on, press and hold the power button to shut down it.
- When the Camera is on, press the power button to go to the standby mode.
- When the Camera is in the standby mode, press the power button to weak up it.

3.3.2 Auto Shutdown

Step 1 Press and hold the wheel to go to the main menu.

Step 2 Rotate the wheel to select .

Step 3 Press the wheel to go to the **System Settings** configuration screen.

Step 4 Rotate the wheel to select .

Step 5 Press the wheel to go to the **Auto shutdown** configuration screen.

Step 6 Rotate the wheel to select the auto shutdown time, and then press the wheel.

If there is no operation in the configured time, the Camera will automatically shut down.

3.4 Image Adjustment

3.4.1 Adjusting IR Light

Rotate the IR light to adjust the beam angle of the light. The boarder the beam angle is, the more spread-out the light will be, but the less the intense will be.

Figure 3-3 Adjust IR light

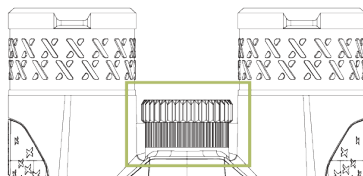

3.4.2 Adjusting Focus

Manually rotate the focusing ring to adjust the focus for a clear image.

Step 1 Aim the thermal lens to the target.

Step 2 Adjust clockwise or counterclockwise the focusing ring until the view is clear.



During the adjustment, do not touch the lens to avoid smudging it; otherwise it may affect the image quality.

Figure 3-4 Adjust focusing

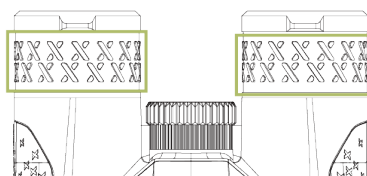

3.4.3 Adjusting Diopter

To get clear images, rotate the diopter ring to fit your eyesight.



For the first-time use, adjust the diopter before configuring the functions.

Step 1 Aim the lens at the target, and then make your eyes close to the eyeshade.

Step 2 Adjust clockwise or counterclockwise the eyepiece to your eyesight.

Figure 3-5 Adjust diopter

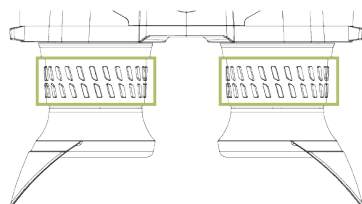

3.4.4 Adjusting Pupil Distance

To get clear images, adjust the pupil distance as needed.



For the first-time use, adjust the pupil distance before configuring the functions.

Step 1 Aim the lens at the target, and then make your eyes close to the eyeshade.

Step 2 Move the eyepieces farther or closer to each other.

Figure 3-6 Adjust pupil distance

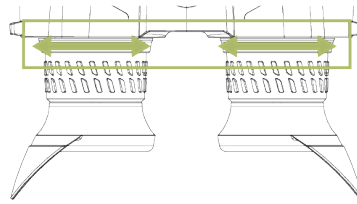



3.4.5 Setting Scene Mode

Step 1 Press and hold the wheel to go to the main menu.

Step 2 Rotate the wheel to select .

Step 3 Press the wheel.

Step 4 Rotate the wheel to select the scene mode, and then press the wheel.

- Day (): Select this mode at daytime and in bright environment. The IR illuminator is off in this mode.
- Night (): Select this mode at night and in dark environment. The IR illuminator is off in this mode.
- Auto (): The day mode and night mode switch automatically according to the environment.

3.4.6 Setting Defog

The image quality is compromised in foggy or hazy environment, and defog can be used to improve image clarity.

Step 1 Press and hold the wheel to go to the main menu.

Step 2 Rotate the wheel to select .

Step 3 Press the wheel to enable or disable the defog function.

3.4.7 Setting EIS

After enabling the Electronic Image Stabilization (EIS) function, it can minimize blurring and compensates for device shake.

Step 1 Press and hold the wheel to go to the main menu.

Step 2 Rotate the wheel to select .

Step 3 Press the wheel to enable or disable the EIS function.

3.4.8 Setting IR Light

The IR light helps to view the target clear in the dark environment.

Step 1 Press and hold the wheel to go to the main menu.

Step 2 Rotate the wheel to select .

Step 3 Press the wheel to set smart IR or select the light level.

3.4.9 Setting Image Mode





You can select different image modes in different scenes for a better view.

Step 1 Press and hold the wheel to go to the main menu.

Step 2 Rotate the wheel to select .





Step 3 Press the wheel.

Step 4 Rotate the wheel to select the image mode as needed.

- Thermal : Select this mode as needed.
- Day Light : Select this mode at day time and in bright environment.
- Twilight : Select this mode at twilight.
- Night Light : Select this mode at night.

Step 5 Press the wheel.

Step 6 Set the parameters for the select mode, including forest mode, brightness, contrast, sharpness, and WDR.

- Forest mode : Rotate the wheel and then press it to enable or disable Forest Mode. Forest mode stands out the targets with high temperature, which makes it easier to find out the targets.
- Brightness : Rotate the wheel and then press it. Rotate the wheel to set the screen brightness level. The higher the level is, the brighter the screen will be.
- Contrast : Rotate the wheel and then press it. Rotate the wheel to set the contrast level. The higher the level is, the more the contrast will be between bright and dark areas.
- Sharpness : Rotate the wheel and then press it. Rotate the wheel to set the sharpness level. The higher the level is, the clearer the picture edges will be.
- WDR : Rotate the wheel and then press it to enable this function as needed.

3.4.10 Setting Digital Zoom

Digital zoom helps to zoom in the image.



On the viewing screen, rotate the wheel to do digital zoom, and the image changes.

3.4.11 Setting Color Palettes

Select the color palettes, which adds color to the thermal image and uses color to indicate the temperature.

Step 1 Press  to select the color palettes.



You can customize the color palettes in  > .

- Visible
Select the color palettes according to your personal preference.

Figure 3-7 Optical-Color



Figure 3-8 Optical-Black white



Figure 3-9 Optical-Yellow



Figure 3-10 Optical-Green



- Thermal
 - ◇ White Hot: The objects with high temperature are white. The higher the temperature, the brighter the color.
 - ◇ Sepia: The objects with high temperature are amber. The higher the temperature, the brighter the color.
 - ◇ Green Hot: The objects with high temperature are green. The higher the temperature, the brighter the color.
 - ◇ Alarm: The objects with high temperature are red. The objects can stand out.
 - ◇ Iron Red: The objects with high temperature are red. The higher the temperature, the brighter the color.
 - ◇ Black Hot: The objects with high temperature are black. The higher the temperature, the darker the color.

Figure 3-11 Thermal-White hot



Figure 3-12 Thermal-Sepia

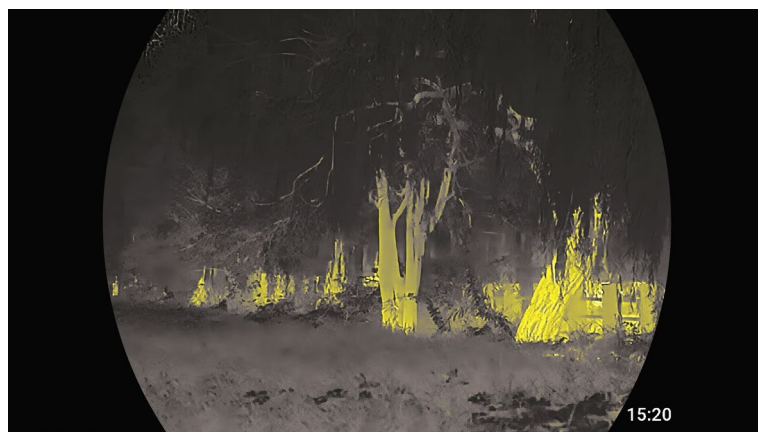

Figure 3-13 Thermal-Green hot

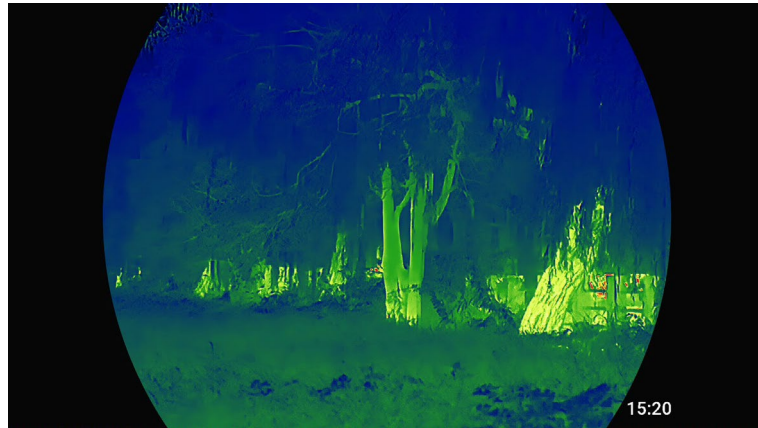

Figure 3-14 Thermal-Alarm

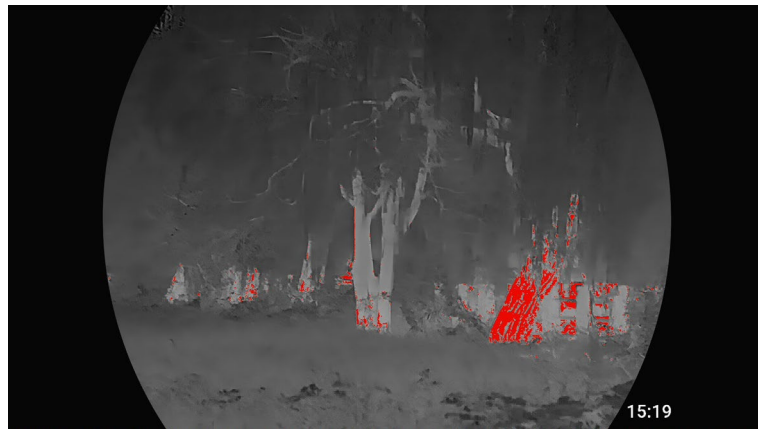

Figure 3-15 Thermal-Iron red

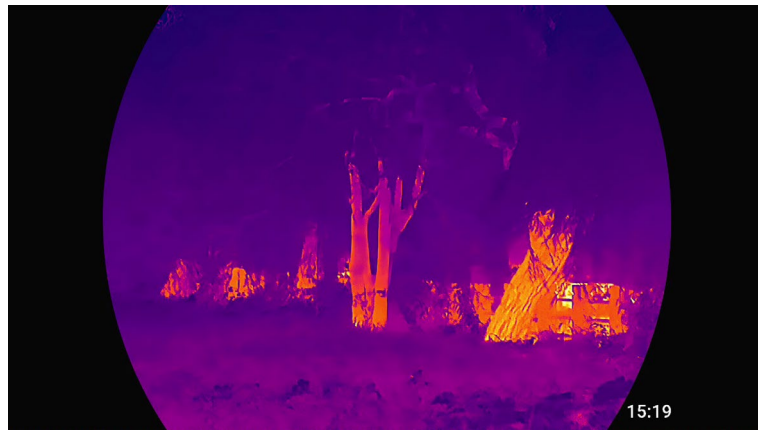



Figure 3-16 Thermal-Black hot



3.4.12 Setting Status Bar

Step 1 Press hold the wheel to go to the main menu.

Step 2 Rotate the wheel to select  > .

Step 3 Press the wheel to enable OSD, and then the status bar is displayed.

Figure 3-17 Status bar

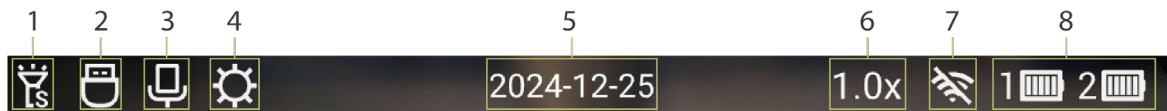







Table 3-1 Description of status bar

No.	Name	Description
1	IR illuminator	Displays the current mode of the IR illuminator.
2	USB	<ul style="list-style-type: none"> : USB is disabled. : USB is enabled.
3	MIC	<ul style="list-style-type: none"> : MIC is disabled. : MIC is enabled.
4	Image mode	Displays the current image mode.
5	Date	Displays the current date.
6	Digital zoom	Supports various digital zooms. The number might be different depending on models.
7	Wi-Fi	<ul style="list-style-type: none"> : The Wi-Fi function is disabled. : The Wi-Fi function is enabled.
8	Battery level	Displays the battery level in real time.

3.4.13 Setting PIP

Press and hold the ranging button to enable the PIP mode, and double-press the ranging button to disable the PIP mode. After enabling PIP mode, the image center is displayed in the upper middle of the screen.

- When you enable the PIP mode in thermal mode, the OSD image in the upper middle of the screen supports digital zoom, 6 color palettes (White Hot, Black Hot, Iron Red, Alarm, Green Hot, Sepia), and 4 visible color palettes (Colour, Black White, Green, Yellow).
- When you enable the PIP mode in visible mode, the OSD image in the upper middle of the screen supports digital zoom and 4 visible color palettes (Colour, Black White, Green, Yellow).

Step 1 Press and hold the ranging button to enable the PIP mode.

Step 2 Press the color palettes button to select the color palettes of the OSD image in the upper middle of the screen.

Step 3 Double-press the ranging button to disable the PIP mode.

3.5 Configuring the Camera

3.5.1 Setting Wi-Fi Connection

After enabling Wi-Fi connection, you can connect your phone to the hotspot of the Camera, and then access the Camera with the app.

The frequency bands and modes and the nominal limits of transmitted power (radiated and/or conducted) applicable to this radio device are the following:

Wi-Fi 2.4 GHz (2.4 GHz to 2.4835 GHz)	20 dBm
Wi-Fi 5 GHz (5.15 GHz to 5.25 GHz)	23 dBm



Some cameras will automatically disable the Wi-Fi function when the battery level is lower than 15%.

Procedure

Step 1 Scan the QR code with your smart phone to install the app.

Figure 3-18 QR code



Step 2 Press and hold the wheel to go to the main menu.

Step 3 Rotate the wheel to select .

Step 4 Press the wheel to select the Wi-Fi.

Step 5 Enable the Wi-Fi of your phone, and then connect to the hotspot of the Camera.



- Wi-Fi name: Model number + serial number.
- Wi-Fi password: The password that you have set during the initialization. For details, See "3.2 Initializing Camera".

Step 6 Log in to the app.

Add access devices according to the prompt.

Related Operations

Changing the Wi-Fi password:

1. Press and hold the wheel to go to the main menu.
2. Rotate the wheel to select .
3. Press the wheel to go to the **System Settings** configuration screen.
4. Rotate the wheel to select .
5. Press the wheel to go to the password setting screen.
6. Rotate the wheel to select the digital to be set, and then press the wheel.

7. Rotate the wheel to set the value, and then press the wheel to save the configuration.
8. Repeat 6-7 to set the numbers of the Wi-Fi password one by one.
9. Rotate the wheel to select **Confirm** and then press the wheel to save the password.

3.5.2 Setting Hot Point

Tracks the point with the highest temperature in real time.

Step 1 Press and hold the wheel to go to the main menu.

Step 2 Rotate the wheel to select .

Step 3 Press the wheel to enable or disable the hot point.

After enabling the hot point, the hot point icon will automatically locate at the points with the highest temperature in the image.

3.5.3 Setting Compass

After enabling the compass information, the direction information will be displayed on the live image, captured images and videos.

Step 1 Press and hold the wheel to go to the main menu.

Step 2 Rotate the wheel to select .

Step 3 Press the wheel to enable or disable the compass function.

After enabling the compass function, the direction information will be displayed on the live image, captured images and videos.

3.5.4 Setting GPS

After enabling the GPS information, the location information will be displayed on the live screen.

Step 1 Press and hold the wheel to go to the main menu.

Step 2 Rotate the wheel to select .

Step 3 Press the wheel to enable or disable the GPS function.

After enabling the compass function, the location information will be displayed on the live screen.

3.5.5 Setting LRF

After enabling the LRF function, and then press , the camera can measure the distance between the observation position and the target with laser.



When measuring the distance, keep the hand and the position steady; otherwise it might affect the measurement accuracy.

Step 1 Press and hold the wheel to go to the main menu.

Step 2 Rotate the wheel to select .

Step 3 Press the wheel to go to the LRF configuration screen.

1) Set LRF dot.

- Constant: The LRF dot will appear all the time.



- Triggered: The LRF dot will appear when you press the laser button.
- 2) Set LRF duration.
- Single: After pressing the laser button, the Camera measures the distance between the camera and the target once.
 - 15 s: After pressing the laser button, the Camera continuously measures the distance between the Camera and the target in 15 s.
 - 30 s: After pressing the laser button, the Camera continuously measures the distance between the Camera and the target in 30 s.
 - 60 s: After pressing the laser button, the Camera continuously measures the distance between the Camera and the target in 60 s.

Step 4 Press  to do ranging.

3.5.6 Setting Thermal Calibration

With FFC (Flat-Field Calibration), the thermal image can be optimized, and you can easily find out temperature changes.

Step 1 Press and hold the wheel to go to the standard menu.

Step 2 Rotate the wheel to select  > .



Step 3 Press the wheel to select the FFC mode.

- Auto: The camera calibrates image automatically every certain period.
- Semi Auto: On the viewing screen, double-press the wheel to calibrate the image.
- Manual: On the viewing screen, close the lens cover, and then double-press the wheel to manually calibrate the image.

3.5.7 Setting DPC

After enabling DPC (Defective Pixels Correction), you can correct the defective pixels in the image.

Step 1 Press and hold the wheel to go to the standard menu.

Step 2 Rotate the wheel to select  > .

Step 3 Press the wheel to go to the DPC configuration screen.

Step 4 Rotate the wheel to select the DPC mode.

- Auto: The Camera automatically corrects the defective pixels in the image.
- Manual: The Camera automatically corrects the defective pixels in the image.
 1. Press the wheel to select X-axis and Y-axis.
 2. Rotate the wheel to make the cursor coincide with the defective pixel.
 3. Press and hold the wheel to save the configuration.



The center of the cursor is the position of the defective pixel.

- Restore: The DPC configuration is restored to the primary state.

3.5.8 Function Settings









Step 1 Press and hold the wheel to go to the main menu.

Step 2 Rotate the wheel to select .

Step 3 Press the wheel to go to the **Function Settings** screen.

Step 4 Rotate the wheel to select function to be configured.

Table 3-2 Function settings

Function	Description
Status bar 	Press the wheel to enable OSD display, and the status bar is displayed. For details, see "3.4.12 Setting Status Bar".
Zoom Step 	Press the wheel and then rotate it to set the zoom step.
MIC 	Press the wheel to enable or disable the microphone. <ul style="list-style-type: none">• On: The videos are recorded with sound.• Off: The videos are recorded without sound.
Logo 	Press the wheel to enable logo display, and the logo will be display on the left lower corner of the screen.
Custom Palettes 	Press the wheel to select the color palettes as needed.
Burning Warning 	Press the wheel to enable the burning warning function. When the lens is in the risk of burning, a note will be displayed on the screen and the shutter will be off automatically.
Power Light 	Press the wheel and then rotate it to set the level.
DPC 	Press the wheel to select the DPC (Defective Pixels Correction) mode, and then you can correct the defective pixels in the image. For details, see "3.5.7 Setting DPC".
FFC Mode 	Press the wheel to select the FFC (Flat-Field Calibration) mode. For details, see #d558e7a1026.

3.5.9 System Settings





Step 1 Press and hold the wheel to go to the main menu.











Step 2 Rotate the wheel to select 

Step 3 Press the wheel to go to the **System Settings** screen.

Step 4 Rotate the wheel to select the parameter to be configured.

Table 3-3 System settings



Parameter	Description
Language 	Press the wheel and then rotate it to select the language as needed.
Always-on Display 	Press the wheel to enable or disable the logo display when the device stands by. <ul style="list-style-type: none">• On: The logo is display on the screen when the device stands by.• Off: The logo is not display on the screen when the device stands by.
Auto Standby 	Press the wheel and then rotate it to set the auto standby time. The Camera will automatically standby in the configured time.
Auto Shutdown 	Press the wheel and then rotate it to set the auto shutdown time. For details, see "3.3.2 Auto Shutdown".

Parameter	Description
USB Mode 	Press the wheel and then rotate it to select the USB mode. <ul style="list-style-type: none"> • ON: The Camera can be used as a storage device. • OFF: Charge the Camera.
Unit 	Press the wheel and then rotate it to select the unit.
Time Settings 	Press the wheel go to the Time Settings screen. <ul style="list-style-type: none"> • Time Display : Press the wheel to enable or disable the function. After enabling this function, the time will be displayed in the status bar. • Time Format : Press the wheel and rotate it to select the time format to be displayed. • Time Settings : Press the wheel to go to the Date&Time page. Rotate the wheel to select the digital to be set, press the wheel and then rotate it to set the value.
Compass Correction 	Press the wheel to initialize the location. In 20 s, rotate the scope along the three axes indicated by the icon, with each axis rotating at least 360°. After 20 s, the calibration completes automatically and exit to the main menu.
Set Wi-Fi Password 	Change the Wi-Fi Password of the Camera. For details, see "3.5.1 Setting Wi-Fi Connection".
Restore 	Press the wheel to go to the restore setting screen, and then rotate the wheel to select the restore mode. <ul style="list-style-type: none"> • Format: Clears images and videos. • Restore Default: Restores parameter configuration to factory defaults. • Factory Defaults: Completely restore device parameters to the factor default, including the Wi-Fi password and zeroing profiles, and more.
Version 	Press the wheel to view the device information

3.6 Video and Snapshot

3.6.1 Recording Videos

Before recording video, make sure that you have disabled the USB mode.

On the viewing screen, press and hold  for 3 seconds to start recording a video. The green icon  and the recording time is display.

Press and hold  again for 3 seconds to stop the recording. When the recording stops, the recording time will display normally.

3.6.2 Capturing Images

Before capturing images, make sure that you have disabled the USB mode.

On the viewing screen, press  to capture images.

The screen will display an icon when the capturing succeeds.

3.6.3 Viewing Local Album

The captured images and recorded videos are stored in the device, and you can view them in the local album.

Step 1 Press and hold the wheel to go to the main menu.

Step 2 Rotate the wheel to select .

Step 3 Press the wheel to go to the Gallery.

- 1) Rotate the wheel to select the image or video that you want to view.
- 2) Press the wheel to view the image or video.



Press  or  to turn the page.

3.6.4 Exporting File

Exports the recorded and captured files.

Step 1 Connect the Camera to the computer through Type-C data cable.

The driver will automatically be installed for first-time connection.



- Connect the cables before starting the Camera. Do not hot swap the Type-C port of the Camera.
- Enable USB mode on the **USB Mode** configuration screen after connecting the Camera to the computer.

Step 2 On the computer desktop, double-click **My Computer**, and then open the Camera disk at a mobile storage device.

Step 3 Select the files to export and copy them to the computer.

The specific computer client is required for playing the exported files.

Step 4 Disconnect the Type-C data cable with the computer.

After connecting the Camera to the computer, images can be displayed on the Camera, but the functions of recording and capturing will not be available.

3.7 Power Supply

You can supply power to the Camera through the rechargeable battery coming with the Camera or charging with the Type-C cable.

3.7.1 Installing the Battery

Step 1 Unlock the battery compartment switch, and then open the cover of the battery compartment.

Step 2 Put two batteries into the battery compartment.



Make sure that the batteries are installed with the positive electrode downward.

Step 3 Install the cover and lock the battery compartment switch.

3.7.2 Charging

The status bar will display battery information after the Camera starts. When the battery is low, charge the Camera timely to make sure the normal function.

- During charging, keep the battery temperature 0 °C to +60 °C (+32 °F to +140 °F).
- Charge the Camera with the data cable that comes with the delivery.

Step 1 Open the sealing cover of the port when charging.

Step 2 Connect the Type-C cable to the port to charge the Camera.



The charging indicator states:

- Red and green lights flashing alternately: charging error.
- Red light on: charging.
- Green light on: fully charged.
- Off: not connected to data cable to charge.

4 System Update

Update the Camera manually or through the app.

4.1 Upgrading Manually

- Step 1 Download the latest firmware from www.pixfra.com/support/download-center to your computer.
- Step 2 Connect the Camera to the computer through Type-C data cable.
- Step 3 Press and hold the wheel to go to the main menu.
- Step 4 Rotate the wheel to select .
- Step 5 Press the wheel to go to the **System Settings** configuration screen.
- Step 6 Rotate the wheel to select .
- Step 7 Press the wheel to enable USB mode.
- Step 8 Copy the upgrading file (.bin), and then shut down the camera.
- Step 9 Disconnect the camera and the computer.
- Step 10 Start the Camera.
- Step 11 Rotate the wheel to select **Confirm**, and then press the wheel to start upgrading.

4.2 Upgrading through App

When the app detects new program for upgrading, it will prompt a notification. Tap **Upgrade** to upgrade the system.

Appendix 1 Compliance Notice

The series products might be subject to export controls in various countries or regions, including without limitation, the United States, European Union, United Kingdom and/or other member countries of the Wassenaar Arrangement. Please consult your professional legal or compliance expert or local government authorities for any necessary export license requirements if you intend to transfer, export, re-export the thermal series products between different countries.